

ISO 1552
PNÖMATİK SİLİNDİRLER
ISO-M SERİSİ Ø32 - Ø125





ISO-M SERİSİ

ISO 15552 - Ø32 - Ø125

MANYETİK YASTIKLAMALI SİLİNDİR

YÜKSEK ISI DAYANIMI,
DAHA UZUN ÖMÜR.

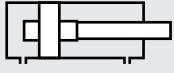

**ISO: ÇİFT ETKİLİ
YASTIKLAMALI SİLİNDİR**

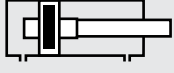

**ISO-M: ÇİFT ETKİLİ
YASTIKLAMALI MANYETİK SİLİNDİR**

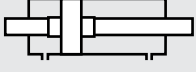

**ISO-D: ÇİFT ETKİLİ
YASTIKLAMALI ÇİFT MİLLİ SİLİNDİR**

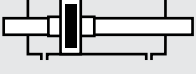

**ISO-MD: ÇİFT ETKİLİ,
YASTIKLAMALI MANYETİK
ÇİFT MİLLİ SİLİNDİR**

Bu ürünlerde yastıklama standarttır.

Sipariş örneği:

ISO-M

Ürün kodu

050-0100

Silindir Ø Strok

EB ÇB

Silindir bağlantıları

R1 K1

Standart dışı varyasyonlar

Standart dışı varyasyonlar:

- R1: Paslanmaz çelik silindir mili (SS 304, SS 316)
- R3: Kapak bağlantı civataları paslanmaz çelik (SS 304)
- R4: Mil ucu somunu paslanmaz çelik (SS 304)
- R5: Silindir mili CK 45 çelik (sert krom kaplamalı)
- M1: Silindir milinde uzatılmış erkek diş
- M2: Dişi diş açılmış silindir mili
- M3: Silindir mili özel diş ölçüsü
- M4: Uzatılmış silindir mili
- E1: Korozyona karşı dayanıklı alüminyum kapaklar (sert eloksallı kaplamalı)
- K1: Maks. 150°C için sızdırmazlık elemanları (viton)
- K2: Mil keçesi NBR+PA
- K3: Sızdırmazlık elemanları NBR
- K4: Mil keçesi viton

Çalışma akışkanı:

Filtrelenmiş ve yağlanmış ya da filtrelenmiş ve yağsız hava

Çalışma sıcaklık derecesi:

Poliüretan (PU) : (-20°C) - (+80°C)
Viton (FKM) : (-30°C) - (+150°C)

Maksimum çalışma basıncı:

10 Bar

Kuvvet değeri:

Silindir Ø mm	Mil Ø mm	İtme ve Çekme kuvvetleri (6 Bar)	
		İtme kuvveti (N)	Çekme kuvveti (N)
32	12	482	415
40	16	754	633
50	20	1178	990
63	20	1870	1682
80	25	3016	2721
100	25	4712	4418
125	32	7363	6881

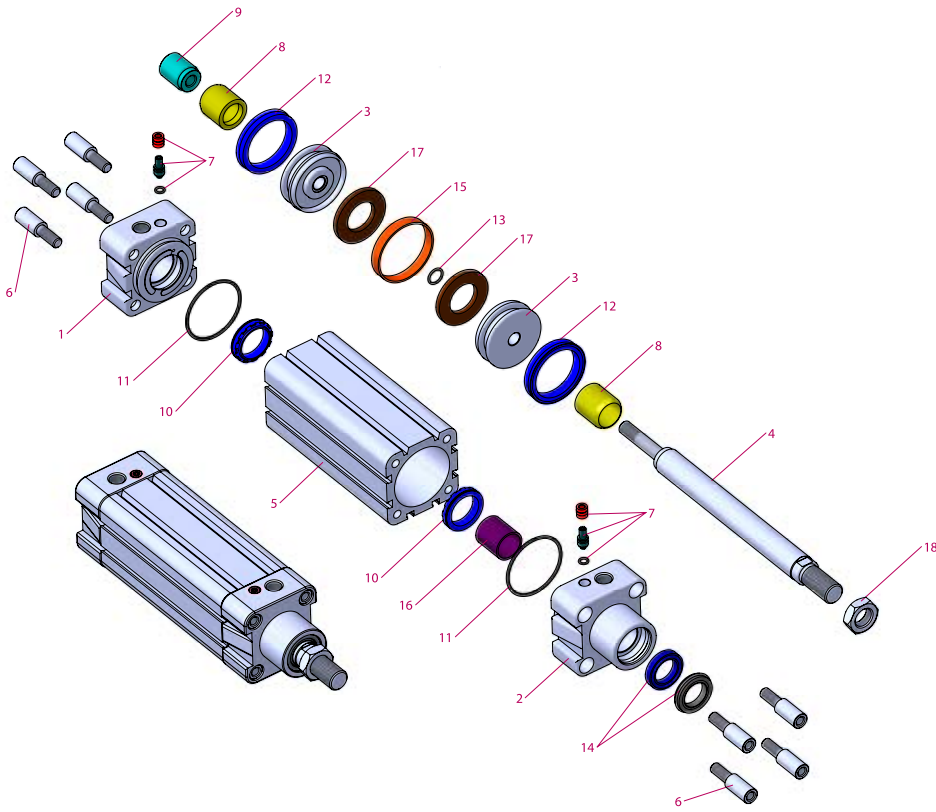
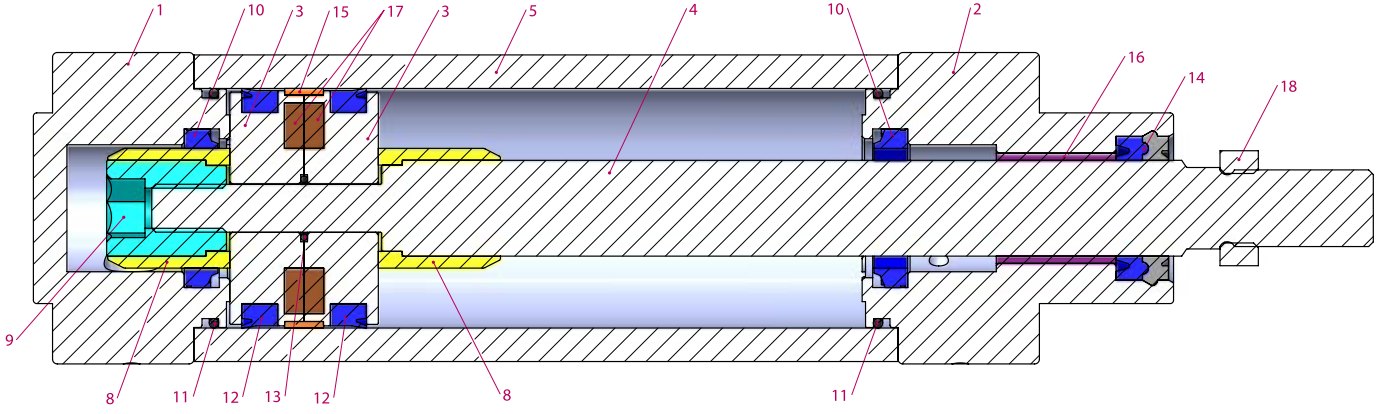

No	Malzeme adı	Malzeme özelliği	Adedi
1	Arka kapak	Alüminyum	1
2	Ön kapak	Alüminyum	1
3	Orta piston	Alüminyum	2
4	Piston mili	X20 Cr13 Sert Krom kaplamalı	1
5	Boru	Al Mg Si 0,5 + Eloksal kaplamalı	1
6	Cıvata	Galvaniz kaplamalı çelik	8
7	Yastıklama vidası	Pirinç + AISI 303 NBR	2
8	Yastıklama plastiği	Polyacetal	2
9	Yastıklama dişlisi	Galvaniz kaplamalı çelik	1
10	Yastıklama keçesi	PU	2
11	Kapak O-ringi	NBR	2

No	Malzeme adı	Malzeme özelliği	Adedi
12	Piston keçesi	PU	2
13	Orta piston O-ringi	NBR	1
14	Mil keçesi	HYTREL + PU	1
15	Yataklama bandı	Polyacetal	1
16	Yataklama burcu	CSB-40	1
17	Mıknatıs		2
18	Somun	Galvaniz kaplamalı çelik	1

Not:

Çap 32' de yastıklama plastiği yerine yastıklama sarısı yastıklama plastiği dişlisi yerine ise yastıklama sarısı dişlisi kullanılmaktadır. (Malzeme: Pirinç)

Çap 125' te yastıklama plastiği yerine yastıklama alüminyumu, yastıklama plastiği dişlisi yerine ise yastıklama alüminyumu dişlisi kullanılmaktadır. (Malzeme: Eloksal kaplı alüminyum)

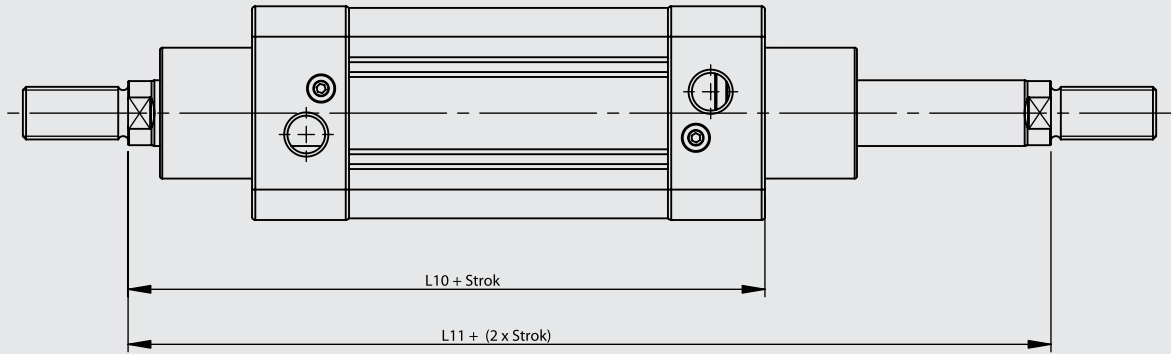
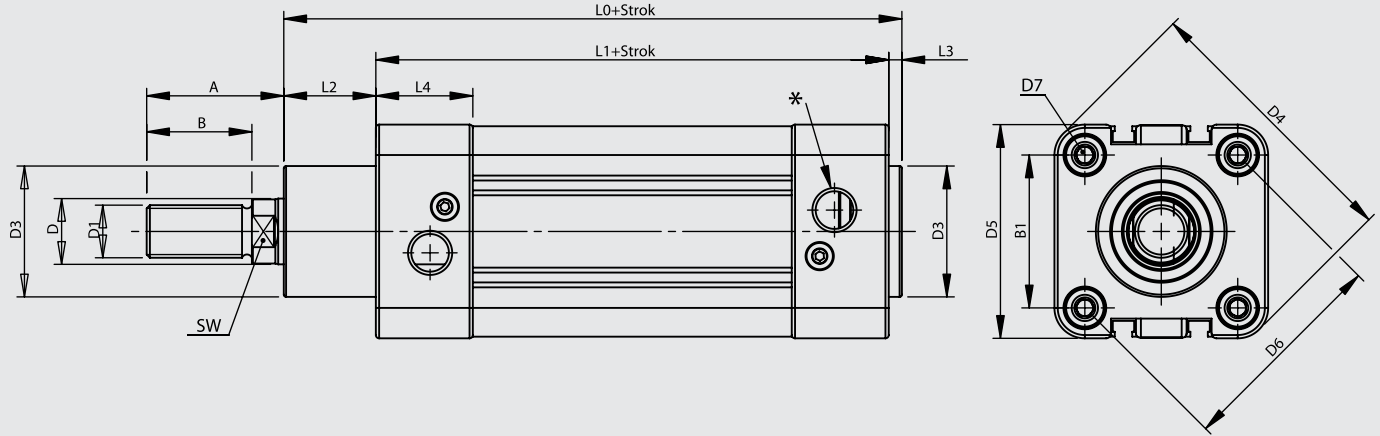

Silindir Ø mm	A	B	B1	D Ø	D1	D3 Ø	D4	D5	D6 Ø	D7	L0	L1	L2	L3	L4	L10	L11	SW	*
32	30	22	32.5	12	M10x1.25	30	59	45	46	M6	116	94	18	4	25	120	146	10	G1/8"
40	34	24	38	16	M12x1.25	35	70.2	54	53.7	M6	129	105	20	4	27	135	165	13	G1/4"
50	41	32	46.5	20	M16x1.5	40	84.2	65	65.7	M8	138	106	28	4	29.5	143	180	17	G1/4"
63	42	32	56.5	20	M16x1.5	45	99.5	76	80	M8	152	121	27	4	34.5	158	195	17	G3/8"
80	52	40	72	25	M20x1.5	45	123.8	94	101.8	M10	167	128	34	4	35	174	220	22	G3/8"
100	52.5	40	89	25	M20x1.5	55	148.8	112	125.9	M10	182.5	138	38.5	4	38	189	240	22	G1/2"
125	73	54	110	32	M27x2	60	179.5	134	155.5	M12	213	160	46	6	44	225	290	27	G1/2"

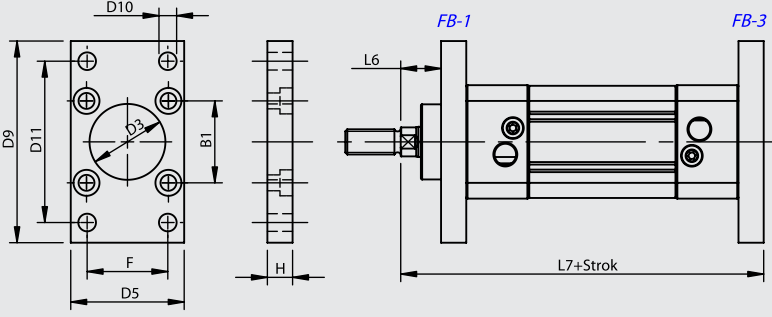
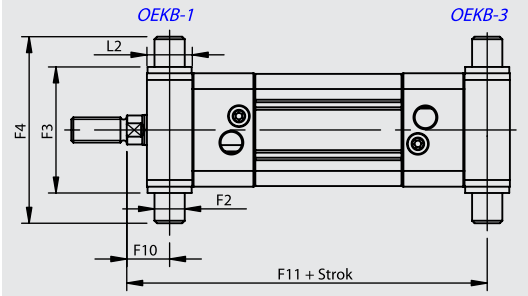
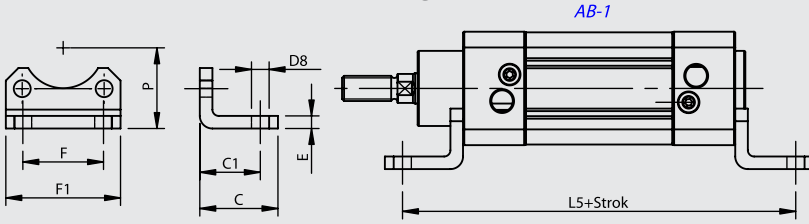
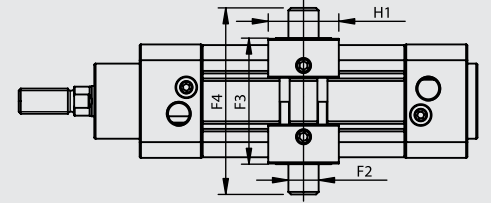
FB Flanş Bağlantı**OEKB Orta Eklem Kapak Bağlantılı****AB Ayak Bağlantı****OEB-3 Orta Eklem Bağlantı**

OEB-3 : Ayarlanabilir Bağlantı

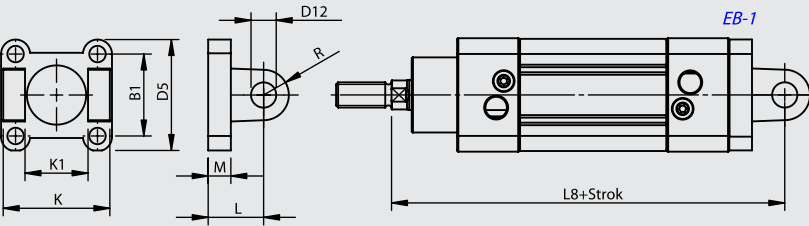
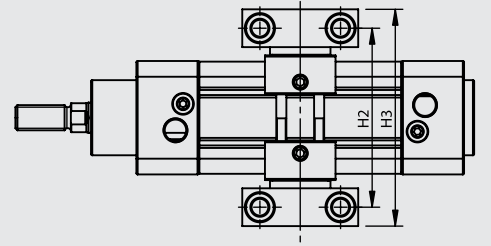
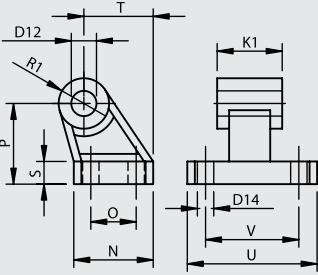
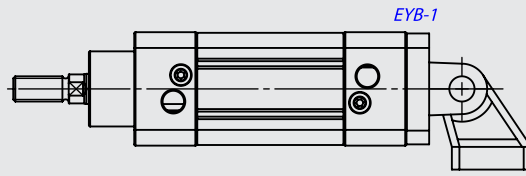
EB Eklem Bağlantı**DMB Destek Masfal Bağlantı****YB Yer Bağlantı****EYB Eklem Yer Bağlantı**

Silindir Ø mm	B1	C	C1	D3 Ø H11	D5	D8 Ø H14	D9	D10 Ø H13	D11 JS14	D12 Ø H9	D14 Ø H13	E	F	F1 JS14	F2 Ø e9	F3 h14	F4	F5 ±0,2	F6	F7	F8	F9 Ø H13	F10	F11
32	32.5	30	24	30	45	7	80	7	64	10	6.6	5	32	45.5	12	50	74	32	46	30	6.8	6.6	17	129
40	38	37	28	35	54	10	90	9	72	12	6.6	5	36	54.5	16	63	95	36	55	36	9	9	20	145
50	46.5	41	32	40	65	10	110	9	90	12	9	6	45	65	16	75	107	36	55	36	9	9	23	157
63	56.5	44	32	45	76	10	120	9	100	16	9	6	50	76	20	90	130	42	65	40	11	11	23.5	171.5
80	72	56	41	45	94	12	150	12	126	16	11	6	63	94	20	110	150	42	65	40	11	11	29	191
100	89	58	41	55	112	14	175	14	150	20	11	6	75	112	25	132	182	50	75	50	13	14	31.8	208.3
125	110	67	45	60	134	16	210	16	180	25	14	8	90	131	25	160	210	50	75	50	13	14	42	248

Silindir Ø mm	H	H1 -0,2	H2	H3	H4	H5 Ø H13	H6	K h14	K1 H14	L	L2	L5	L6	L7	L8	M	N	O JS14	P JS16	R	R1	S	T	U	V JS14
32	10	28	71	86	15	11	10.5	45	26	22	18	142	16	130	142	9	31	18	32	10	10	8	27.5	51	38
40	10	28	87	105	18	15	12	52	28	25	20	161	20	145	160	9	35	22	36	12	11	10	30.5	54	41
50	12	34	99	117	18	15	12	60	32	27	28	170	25	155	170	11	45	30	45	13	12	12	40.5	65	50
63	12	34	116	136	20	18	13	70	40	32	27	185	25	170	190	11	50	35	50	16	15	12	44.5	67	52
80	16	34	136	156	20	18	13	90	50	36	34	210	30	190	210	14	60	40	63	16	15	14	57	86	66
100	16	44	164	189	24.5	20	16	110	60	41	38.5	220	35	205	230	14	70	50	71	20	19	15	65	96	76
125	20	44	192	217	24.5	20	16	130	70	50	46	250	45	245	275	15	90	60	90	25	22.5	20	85	124	94

FB Flanş Bağlantı

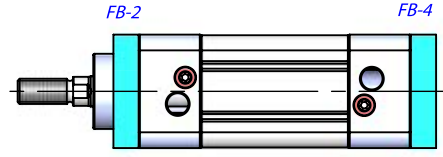
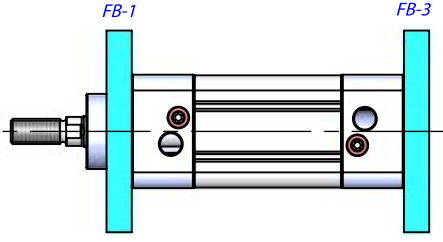

AB Ayak Bağlantı

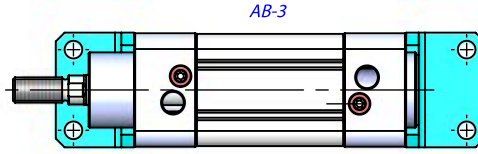
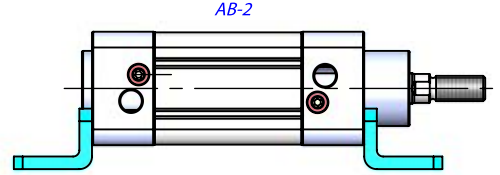
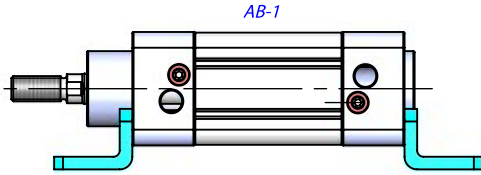

EB Eklem Bağlantı

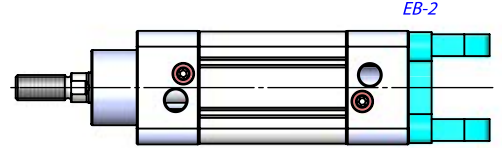
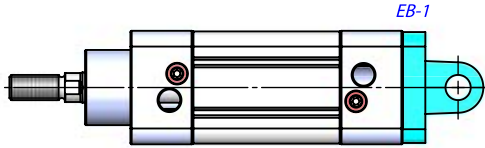

EYB Eklem Yer Bağlantı

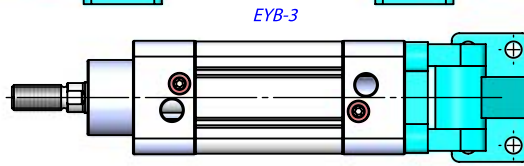
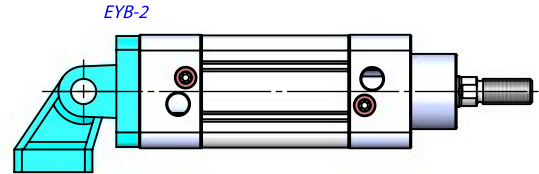
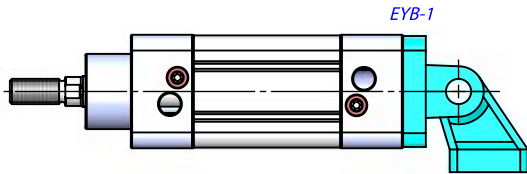

OEKB Orta Eklem Kapak Bağlantılı

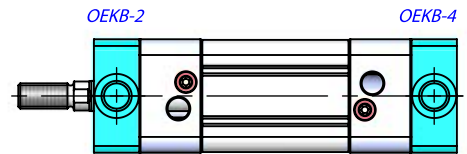
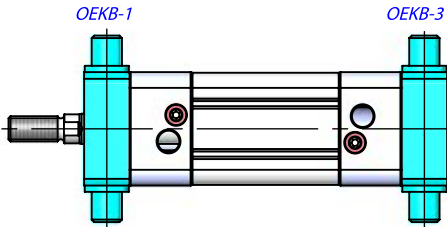

OEB Orta Eklem Bağlantı

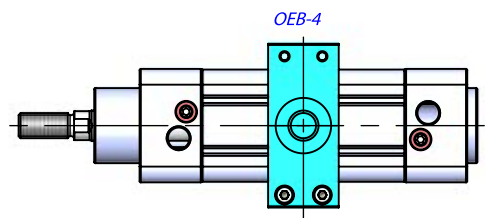
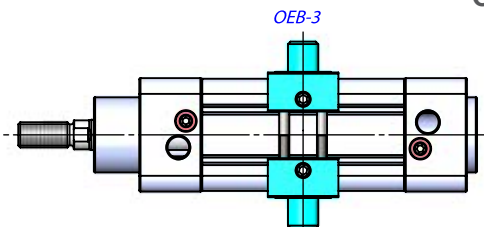

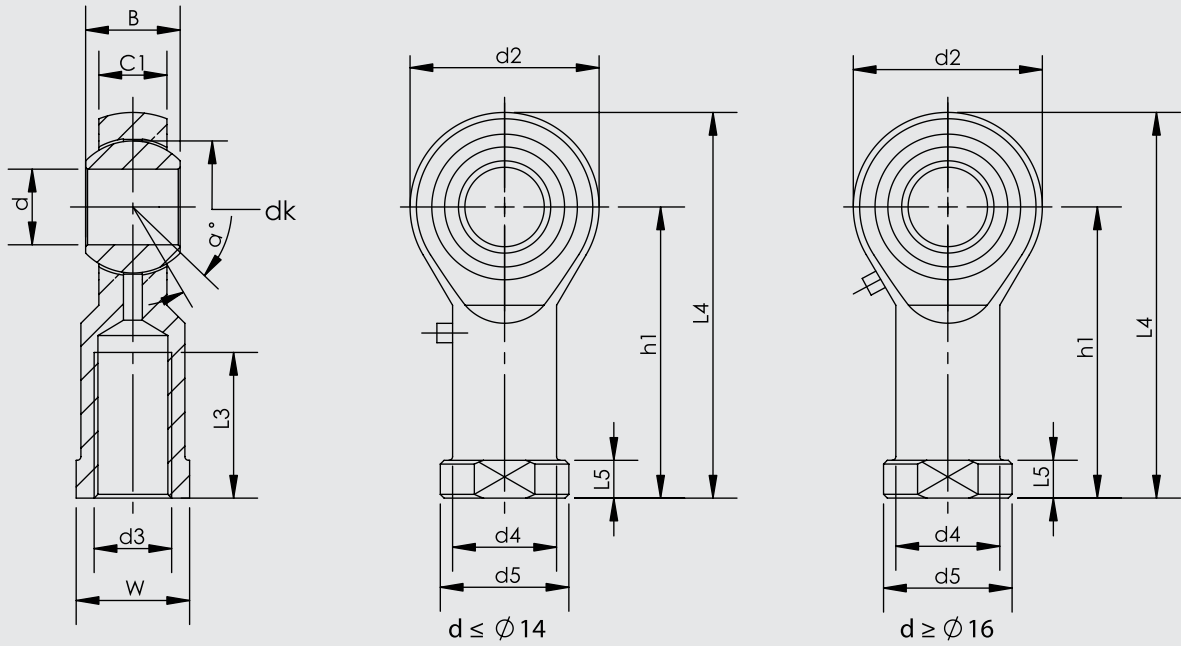

Parça No.	Ölçüler (mm)													
	d	d3 6H	B	C1	W	L3 min	d2	L4	h1	L5	d4	d5	dk	α°
KMB 10 -1	10	M10x1.25	14	10.5	17	20	26	56	43	6.5	15	19	19.05	13
KMB 12 -1	12	M12x1.25	16	12	19	22	30	65	50	6.5	17.5	22	22.225	13
KMB 16 -1	16	M16x1.5	21	15	22	28	40	84	64	8	22	27	28.575	15
KMB 20	20	M20x1.5	25	18	30	33	50	102	77	10	27.5	34	34.925	14
KMB 28	28	M27x2.0	35	24	41	48	66	136	103	14	37	46	47.6	15
KMB 30-1	30	M27x2.0	37	25	41	51	70	145	110	15	40	50	50.8	17
KMB 30	30	M30x2.0	37	25	41	51	70	145	110	15	40	50	50.8	17

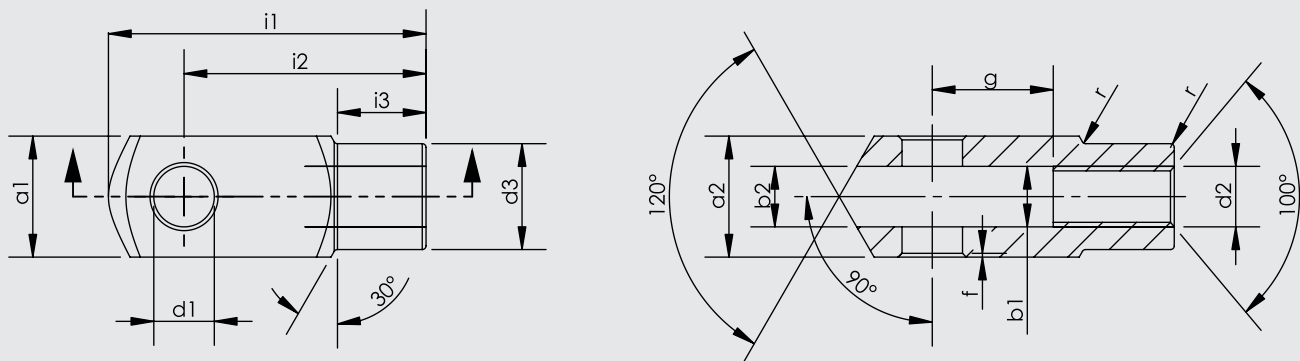

Silindir Ø mm	d1 H9	g ±0,5	a1 h 11	a2 +0,3 -0,16	b1 B 13	b2	d2 6H	d3 ±0,3	f ±0,2	i1 ±0,5	i2	i3 ±0,2	r
32	10	20	20	20	10	10	M10x1.25	18	0.5	52	40	15	0.5
40	12	24	24	24	12	12	M12x1.25	20	0.5	62	48	18	0.5
50	16	32	32	32	16	16	M16x1.5	26	1	83	64	24	1
63	16	32	32	32	16	16	M16x1.5	26	1	83	64	24	1
80	20	40	40	40	20	20	M20x1.5	34	1.5	105	80	30	1.5
100	20	40	40	40	20	20	M20x1.5	34	1.5	105	80	30	1.5
125	25	50	50	50	25	25	M27x2	42	1.5	132	100	36	1.5