

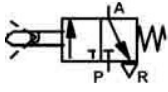







Mekanik Kumandalı Ağır Hizmet Serisi Pnömatik Valfler

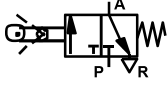

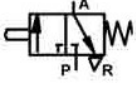

Çubuklu - Yay Dönümlü (P=0-10 bar)		
	TY - 32 - 1/8m	
	TY - 32 - 1/4m	

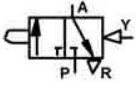
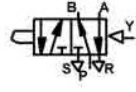

Çubuklu Makaralı - Yay Dönümlü (P=0-10 bar)		
	TMY - 32 - 1/8m	
	TMY - 32 - 1/4m	

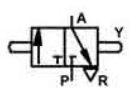
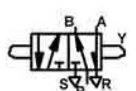

Pimli - Yay Dönümlü (P=0-10 bar)		
	BLY - 32 - 1/8	
	BLY - 32 - 1/4m	
	BY - 42 - 1/4	
	BY - 52 - 1/8m	
	BY - 52 - 1/4m	

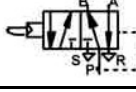
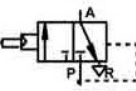
Pimli - Basınç Dönümlü (P=0-10 bar, P≥1 bar)		
	BP - 32 - 1/8m	
	BP - 32 - 1/4m	
	BP - 52 - 1/8m	
	BP - 52 - 1/4m	

İki Yönde Pim Kumandalı (P=0-10 bar)		
	BB - 32 - 1/8	
	BB - 32 - 1/4m	
	BB - 52 - 1/8m	
	BB - 52 - 1/4m	

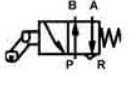
Hassas Pim Kumandalı (P=1-10 bar)		
	BSO - 32 - 1/4m	
	BSO - 52 - 1/4m	

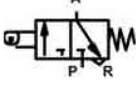
İki Yönde Pim Kumandalı (P=0-10 bar)		
	MTY - 32 - 1/4	
	MTY - 42 - 1/4	

Makaralı - Yay Dönümlü (P=0-10 bar)		
	MY - 32 - 1/4	
	MY - 42 - 1/4	

Değişiklik Hakkımız Saklıdır

BB - 32 - 1/4m

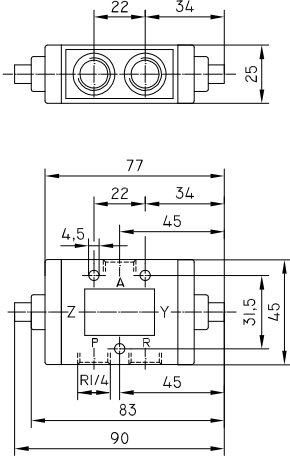

BB - 52 - 1/4m

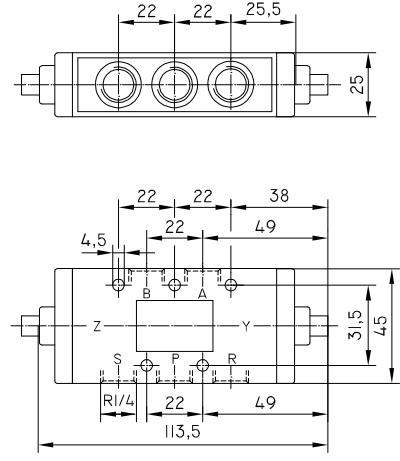

BY - 32 - 1/4m

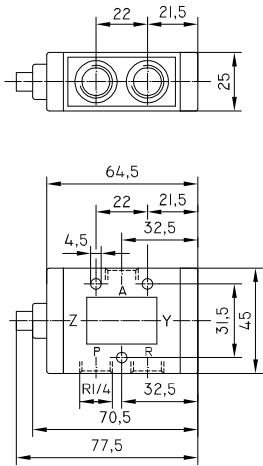

BY - 52 - 1/4m

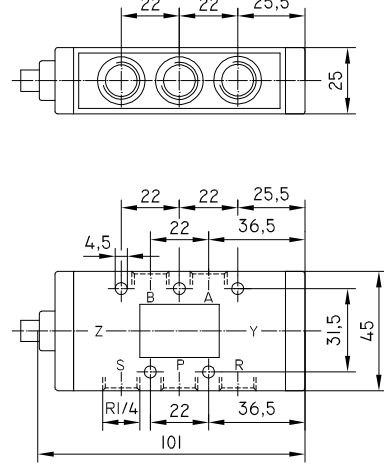

BP - 32 - 1/4m

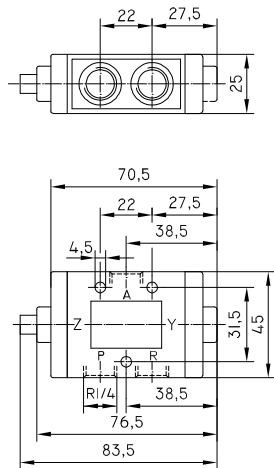

BP - 52 - 14m

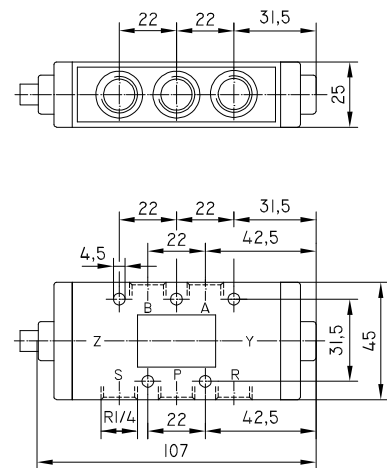

Mekanik Kumandalı Ağır Hizmet Serisi Pnömatik Valfler Valfler (Ölçüler)



BY - 32 - 1/4

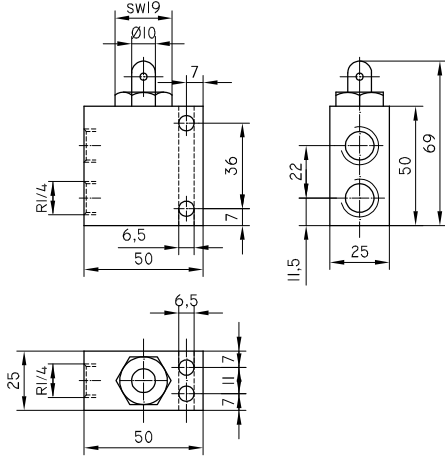

BLY - 32 - 1/4

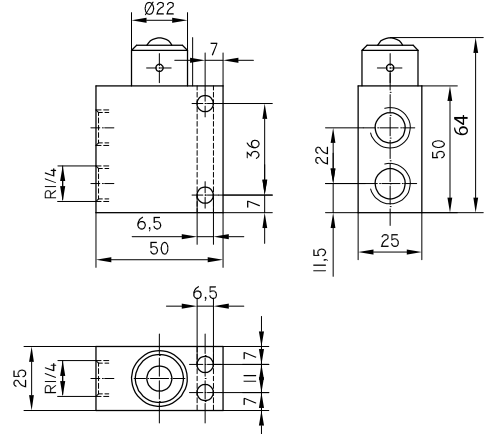

MY - 32 - 1/4

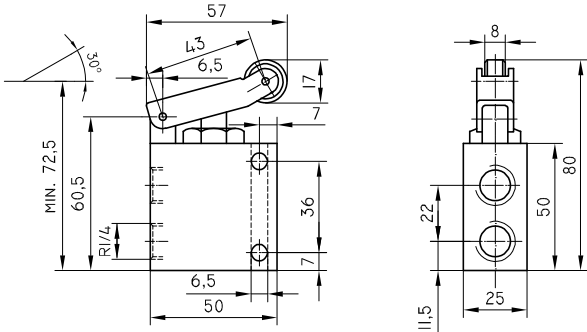

MTY - 32 - 1/4

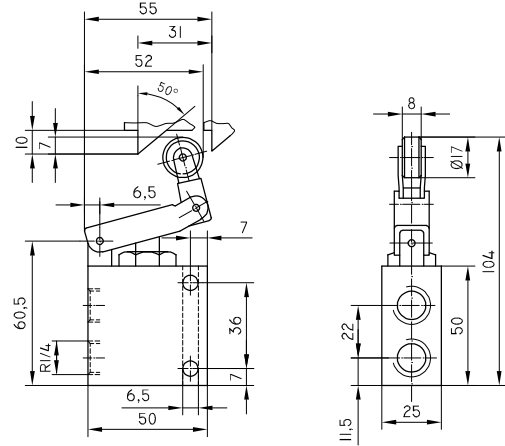

BY - 42 - 1/4

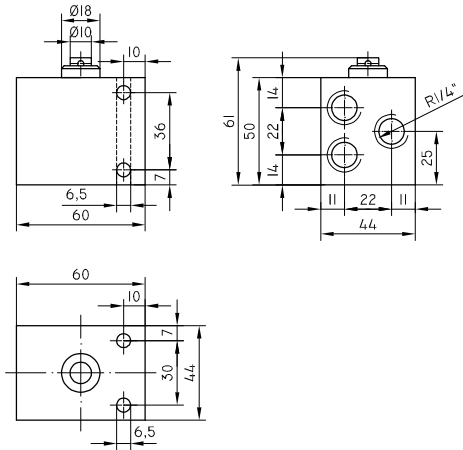

MY - 42 - 1/4

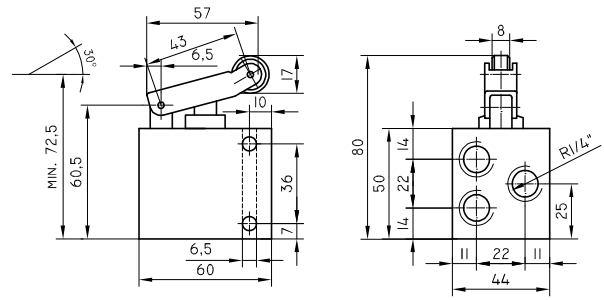

MTY - 42 - 1/4

